

Oasis-L344 Outdoor Cabinet Liquid Cooling Energy Storage System

User Manual

Version Number: A2

Sunwoda Energy Technology Co., Ltd.

Add: 15/F, Building B, Xinda R&D Base, No.18 Tangjia South Road,

Guangming District, Shenzhen, Guangdong, China.

E-mail: service@sunwoda.com

Tel: 0755-23698792

Web: <http://www.sunwoda.com>

Outlined

Thank you for choosing Oasis-L344 Outdoor Cabinet Liquid Cooling Energy Storage System from Sunwoda. With innovative design and perfect quality management, this system operates safely, stably, reliably and with long service life in work, meanwhile the product is simple to operate, easy to use and has a series of perfect protection functions.

This manual focuses on the safe operation of this system, so be sure to read this manual carefully before operating. If you encounter any problems in operating the equipment, please consult this manual, the instructions in this manual can help you to solve most of the difficulties in installation and operation. Contact your dealer or supplier if you need help.

Safety Precautions

Operational safety

- 1、 Before using this equipment, please read the "Safety Precautions" and the accompanying "Power Connection and BMU Replacement Instructions" carefully to ensure proper and safe use, and keep the instructions in a safe place.
- 2、 When operating, observe all warning signs and proceed as required.

Electrical safety

- 1、 Before powering up the unit, make sure that the unit's power cord is properly connected and the earth wire is connected.
- 2、 When the unit needs to be rewired, switch the unit off, disconnect the power and battery switches and ensure that the system is completely shut down, otherwise the outputs may still be charged and there is a risk of electric shock.





Battery safety

- 1、 Battery life shortens with increasing ambient temperature. Regular maintenance ensures that the equipment works properly and guarantees adequate back-up time.
- 2、 Lithium battery maintenance must be carried out by personnel with specialist knowledge of batteries.
- 3、 Batteries present electric shock hazard and a short circuit hazard. To avoid electric shock and injury accidents, observe the following warnings during battery maintenance:
 - A、 Do not wear watches, rings or similar metal objects.
 - B、 Use insulated tools.
 - C、 Wear rubber shoes and gloves.
 - D、 Metal tools or similar metal parts must not be placed on the battery.
 - E、 The load connected to the battery must be disconnected before removing the battery connection terminals.
- 4、 Do not expose the battery to fire as this may cause an explosion and endanger personal safety.

Do not short-circuit the positive and negative terminals of the battery, which can cause electric shock or fire.

Interpretation of the Logo

Notation	An explanation of the meaning of words or phrases
	Read the user manual before use or maintenance!
	High voltage hazard, contact prohibited!
	Be safe and potentially dangerous!
	WARNING: Dangerous arcing!
	Be aware of high temperatures and prohibit contact!
	Beware of corrosion!
	Sine wave alternating current!
	DC!
	Protective grounding!
	Protective gloves must be worn!
	Smoke and fire are strictly prohibited!
	Trampling is strictly prohibited!

	Recyclable!
	When your product reaches the end of its useful life, make sure that it is taken to WEEE recycling station in your country. This ensures that the product is disposed of and handled correctly and that no harmful substances are released into the environment.
	When your battery/batteries reach the end of their useful life, make sure that the batteries to be recycled are taken to a battery recycling station in your country.
	Danger! Access is prohibited! Only professionally authorized personnel may touch the housing or enter!

CONTENT

Outlined	1
Safety Precautions	1
Interpretation of the Logo	2
CONTENT	1
Chapter I. Products	3
1.1 Nameplate Information	3
1.2 Parameters	4
1.2.1 System Parameters	4
1.2.2 List of Equipment	5
1.3 Structural Layout	5
1.4 Introduction to Composition	6
1.4.1 Overview	6
1.4.2 Battery System	6
1.4.3 Distribution System	12
1.4.4 Temperature Control Systems	13
1.4.5 Fire Extinguishing Systems	13
1.4.6 Grounding Systems	14
Chapter II. Installation	15
2.1 Storage and Transport	15
2.1.1 Storage	15
2.1.2 Transport	15
2.1.3 Outdoor Cabinet Integrity Checks	15
2.2 Mechanical Installation	17
2.2.1 General Requirements	17
2.2.2 Box Installation	18
2.3 Electrical Installation	20
2.3.1 Cable Routing Requirements	20
2.3.2 Cable Fixing and Protection	21
2.3.3 Outdoor Cabinet Wiring	22
2.3.4 Electrical Installation Completion Inspection	27
Chapter III. Operation	29

3.1 Preparation for Start-up	29
3.2 Operating Instructions	29
3.2.1 Operating Instructions for the HVDC Section	29
3.2.2 Operating Instructions for the Power Distribution Section	30
3.2.3 Operating Instructions for the Water Cooler	31
3.2.4 Description of the Fire Protection System	31
3.2.5 Local Monitoring Operation Description	32
3.3 Power-up Procedure	33
3.4 Downtime Procedures	33
3.4.1 Normal Shutdown Procedure	33
3.4.2 Emergency Shutdown Procedures	33
Chapter IV Product Maintenance	34
4.1 Maintenance of Security Matters	34
4.2 Maintenance Work and Cycles	34
4.2.1 Battery System Maintenance	34
4.2.2 Battery Box Maintenance	35
4.2.3 Main control Box Maintenance	37
4.2.4 Maintenance of Water Coolers	38
4.2.5 Maintenance of Fire Protection Systems	41
4.2.6 Maintenance of the Box	41
4.2.7 BMS/in Situ Monitoring System Maintenance	42
4.3 Replacement of Electrical and Electronic	42
Chapter V Factory Default Parameters	44
Chapter VI Failure Analysis and Handling	56
6.1 Troubleshooting	56
6.2 Common Troubleshooting Chart	57

Chapter I. Products

Oasis-L344 liquid cooling outdoor cabinet energy storage system technical solution is based on Sunwoda's mature lithium battery system management experience, adopting long-life lithium iron phosphate batteries with superior performance, technologically advanced balanced management system; large-capacity power electronic converter technology, massive data monitoring and storage technology, power system optimized control technology and other aspects of advantageous technology. It has formed a set of lithium battery energy storage system with leading technology, reliable quality and excellent performance, and adopts balanced battery management and automatic battery maintenance to meet the needs of customers in high-power applications.

1.1 Nameplate Information









 深圳市欣旺达能源科技有限公司 Sunwoda Energy Technology Co., Ltd.	
Product Name	Rechargeable Lithium Iron Phosphate Battery System
Battery Type	LiFePO ₄
Rated Capacity	280Ah
Model No./Nominal Voltage/Rated Energy	
<input type="checkbox"/> Oasis-L43	153.6Vdc/43kWh IFpP74/176/208[(48S)E]-20NA/90
<input type="checkbox"/> Oasis-L86	307.2Vdc/86kWh IFpP74/176/208[(48S)2S]E/-20NA/90
<input type="checkbox"/> Oasis-L129	460.8Vdc/129kWh IFpP74/176/208[(48S)3S]E/-20NA/90
<input type="checkbox"/> Oasis-L172	614.4Vdc/172kWh IFpP74/176/208[(48S)4S]E/-20NA/90
<input type="checkbox"/> Oasis-L215	768Vdc/215kWh IFpP74/176/208[(48S)5S]E/-20NA/90
<input type="checkbox"/> Oasis-L258	912.6Vdc/258kWh IFpP74/176/208[(48S)6S]E/-20NA/90
<input type="checkbox"/> Oasis-L301	1075.2Vdc/301kWh IFpP74/176/208[(48S)7S]E/-20NA/90
<input type="checkbox"/> Oasis-L344	1228.8Vdc/344kWh IFpP74/176/208[(48S)8S]E/-20NA/90
Short Circuit Current/Time	8000A/4ms
Operating Temperature	-20℃~45℃
Relative Humidity	5% RH~95% RH
IP Grade	IP55
Protective Class	I
Pollution Class	III
Maximum Altitude	2000 m
    SN:	
   	

Figure 1-1 Outdoor cabinet nameplate

1.2 Parameters

1.2.1 System Parameters

Table 1-1 System parameters

Serial number	Project Description	Specification	Note	
1	System nominal capacity	344kWh	DC side	
2	Rated charging power	172kW	Maximum support continuous 344KW	
3	Rated discharge power	172kW	Maximum support continuous 344KW	
4	DC Voltage Range	1075.2V~1382.4VDC		
5	Output wiring method	Plug in quickly		
6	Working environment temperature	-30°C~55°C	-30°C~-20°C、45°C~55°C Maximum support 172KW	
7	Storage ambient temperature	-30°C~60°C		
8	Operating relative humidity	5~95%		
9	Storage relative humidity	5~95%		
10	Altitude	≤2000m		
11	Protection class	IP55		
12	Contamination level	III		
13	Outdoor cabinet dimensions W *D* H	1570mm*1350mm*2380mm		
14	Outdoor cabinet weight	3600±100kg		
16	Outdoor cabinet port	Power port	1 way	Plug in quickly
		External power take-off port (computing)	2 way	Electricity for liquid cooler and electricity for monitoring equipment.
		Grounding port	1 way	
		Communication port	1 way	CAN
17	Transport requirements	Sea/land transport		

1.2.2 List of Equipment

Table 1-2 System equipment list

Serial number	Name (of a thing)	Quantities	Note
1	Battery rack	1	8 packs in 1 cluster, total capacity 344kWh
2	High voltage box	1	Including disconnect switches, fuses, relays, etc.
3	Liquid cooler	1	Including piping
5	Fire protection system	1	Aerosols, detectors, exhaust fans, blast panels
6	Harness	1	Battery cluster power harnesses, communication harnesses
7	Outdoor cabinet	1	

1.3 Structural Layout

Designed for easy maintenance, the functional area is divided into two parts, a battery compartment and an equipment compartment. The cabinet is equipped with a water-cooled unit, which is combined with a high-voltage box and a switchboard in the equipment compartment. The fire-fighting system is placed in the battery compartment, and the battery compartment and the equipment compartment are equipped with a wire channel, which is used as a cable access for power distribution, communication and power cables.

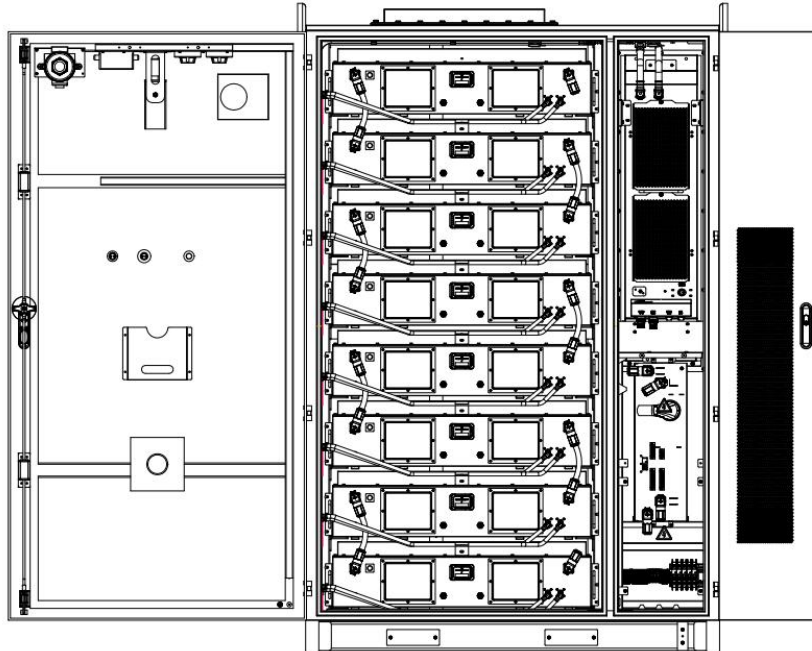

Figure 1-2 Structure layout

1.4 Introduction to Composition

The outdoor cabinet energy storage system consists of battery box, main control box, switchboard, fire protection system, temperature control system, grounding system and so on.

1.4.1 Overview

The energy storage battery system consists of an energy storage battery section and a battery management system (BMS).

The energy storage battery part adopts a single 280Ah/3.2V lithium iron phosphate cell, assembled by series-parallel way, 48 strings of single batteries form a battery box; 8 battery boxes form a battery cluster; multiple liquid cooling outdoor cabinets can be managed by the ESMU in the external convergence cabinet, and accessed to the customer side of the PCS through the convergence cabinet.





The energy storage battery management system consists of Battery Management Unit BMN, Battery String Management System BCM and Battery Stack Management System ESMU. The BMS system has the functions of analogue signal high-precision detection and reporting, fault alarm, battery protection, parameter setting, and information interaction with other equipment.

The battery compartment is equipped with an aerosol fire extinguishing device, which can be triggered by the control box to spray and realize the function of extinguishing the battery compartment when the ambient temperature is detected to be $>70^{\circ}\text{C}$.

1.4.2 Battery System

The lithium iron phosphate (LFP) battery used in the battery system has the characteristics of high specific energy, long cycle life, large charging and discharging multiplier, safety and non-pollution, and has been widely used in the field of peak-frequency regulation and other energy storage. The battery cells form a battery box through 48 strings, 8 battery boxes form a battery cluster, each battery cluster controls the power output through a master control box, and 8 battery clusters form a battery stack to access the PCS, which achieves effective management and full use of the battery cells through the reasonable configuration and encapsulation of the battery cells.

Table 1-3 Specification parameters of energy storage units

Serial number	Project description	Unit topology	Rated voltage (V)	Rated capacity (Ah)	Storage power (kWh)	Note
1	Battery cell		3.2	280	0.896	LFP
2	Battery pack		153.6	280	43	1P48S
3	Battery rack		1228.8	280	344	8 packs in series
4	Outdoor cabinet		1228.8	280	344	

1.4.2.1 Battery pack Specification Parameters

Table 1- 4 PACK specification parameters

Model number	B1F-154/43-CN
Nominal capacity	280Ah
Nominal voltage	153.6V
Rated charging current	140A
Rated discharge current	140A
Maximum charging current	280A
Maximum discharge current	280A
Voltage range	134.4~172.8V
Stored energy	43kWh
Storage temperature range (°C)	-30°C~60°C
Charging operating temperature range (°C)	0°C~60°C
Discharge operating temperature range (°C)	-30°C~60°C
Structure size (W*D*Hmm)	1036*876*258
Weight parameters	326±5kg

1.4.2.2 Panel description

The battery module is divided into two types, A and B, except for the polarity of the positive and negative terminals of the power port, other parameters are the same, the panel schematic is shown below:

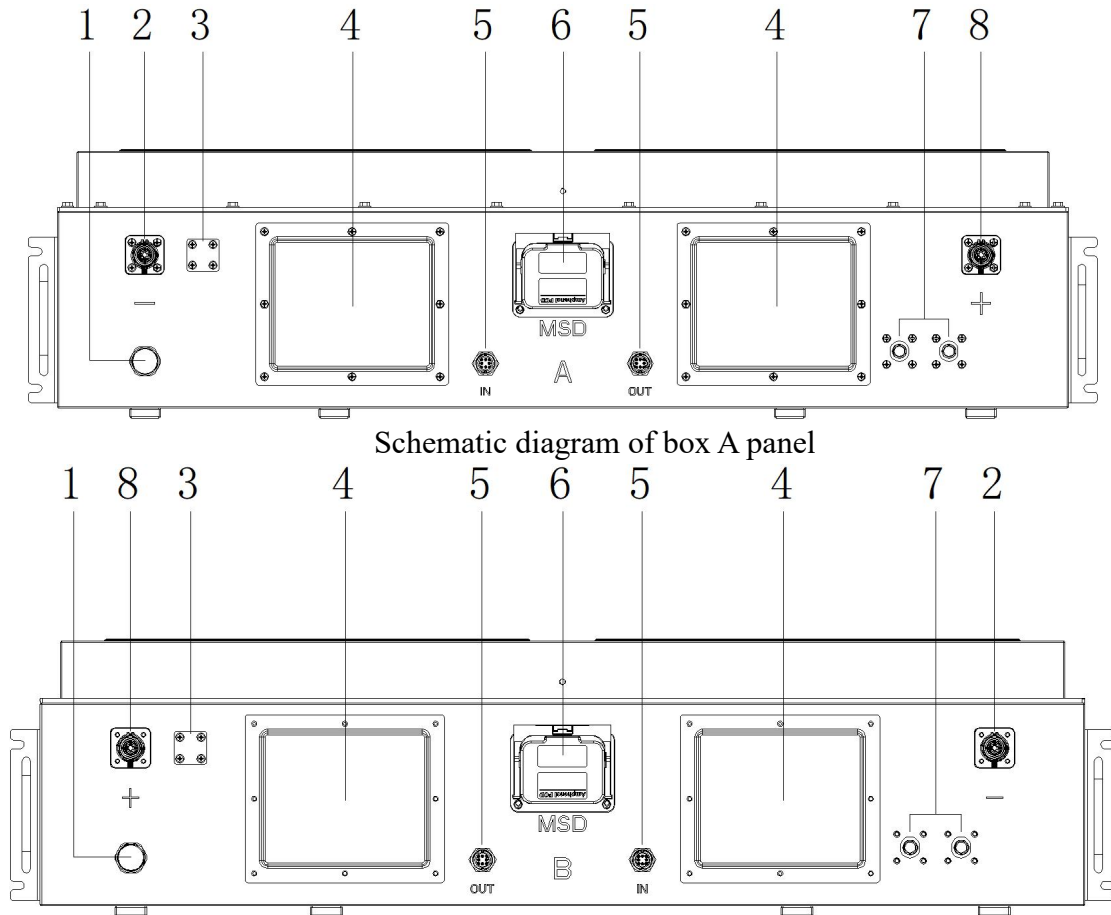

Schematic diagram of box B panel
Figure 1-1 Battery Pack Panel Diagram

Table 1-5 PACK part descriptions

Serial number	Descriptions	Clarification
1	Relief valve	VE-M582-00-111 Voir
2	Negative extremist	ES103-01M8-1SYW-07
3	Fire plugs	Fire protection reserved interface inside the module
4	BMU maintenance board	207*172*12mm

	(L*W*H)	
5	CAN communication connector (IN/OUT)	8 pole airline socket (IN/OUT)
6	MSD manual maintenance switch	GCMSDP000/GCMSDRFS 1500VDC 350A
7	Coolant inlet and outlet	
8	Positive extremist	ES103-01M8-2SYX-07

Table 1-6 PACK communication port definitions

IN	Pin number	1	2	3	4	5	6	7
	Pin definitions	24V-	24V+	IO1	CANL	CANH	Shielding layer	K1
	Pin description	BMU power supply negative	BMU power positive	BMU code	CAN high Communication with the main control box	CAN low Communication with the main control box	Screened ground	Repair switch feedback
OUT	pin number	1	2	3	4	5	6	7
	Pin definitions	24V-	24V+	IO1	CANL	CANH	Shielding layer	K2
	Pin description	BMU power supply negative	BMU power positive	BMU code	CAN high communication with the main control box	CAN low Communication with the main control box	Screened ground	Repair switch feedback

1.4.2.3 Description of the Battery System

Battery system consists of 8 packs connected in series, 8 packs are connected in series from top to bottom, the total positive and total negative of the battery system are connected to B+ and B- of the high voltage box; P+ and P- of the high voltage box are used as the DC high-voltage output interfaces, which are externalized to the convergence cabinet, and converged to the high-voltage DC side of the PCS.

1.4.2.4 Introduction to the Master Control Box

Table 1-7 Parameters of main control box

Rated voltage	1500Vdc
Maximum current	400A
Communication interface	Cascade/CAN
Communication protocols	CAN/standard modbus
Structural dimensions	600*700*200
Weight parameters	33±3kg

1.4.2.5 HV BMS Control Panel Description

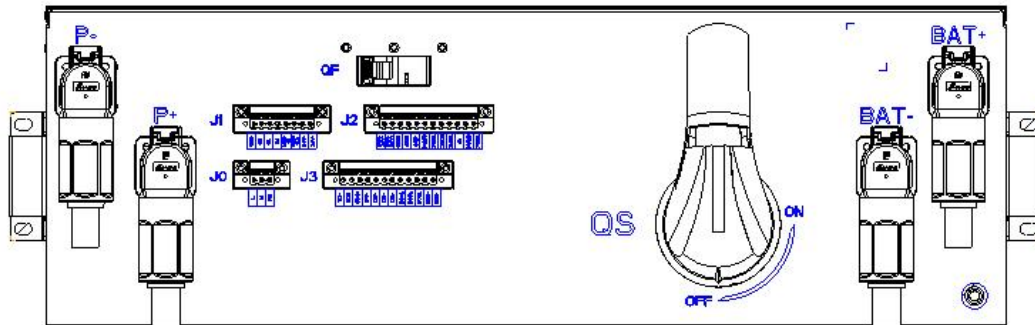

Figure 1-4 Main control box panel port

Terminal Description:

Table 1-8 Main control box panel terminal descriptions

Serial number	Descriptions	Model number	Role
1	BAT1-	Quick connectors	Connect the negative terminal of the battery cluster
2	BAT1+	Quick connectors	Connect the positive terminal of the battery cluster
3	P+	Quick connectors	Battery cluster output positive
4	P-	Quick connectors	Battery cluster output positive
5	J1	Phoenix terminal	Battery cluster intra-communication
6	J0	Phoenix terminal	BMS AC power supply
7	J2	Phoenix terminal	Cluster external communication
8	J3	Phoenix terminal	DODI signal
9	QF	Distribution circuit breakers	Main control box power supply circuit breaker
10	QS	Power circuit breakers	Battery cluster output circuit breaker

Communication port description:

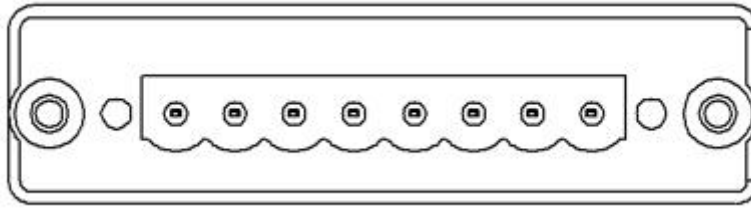

	Slave communication		Address inquiry	Inspect		Slave supply	
	OH	OL	I01	MSD-K1	MSD-K2	24V+	24V-
GND							

Table 1-9 Definition of internal communication terminal (J1)

Pinout	1	2	3	4
Define	GND	OH	OL	IO1
Hidden meaning	CAN shield ground	CAN H	CAN L	Auto-programming
Pinout	5	6	7	8
Define	MSD-K1	MSD-K2	24V+	24V-
Hidden meaning	Maintenance switch dry contact	Maintenance switch dry contact	BMU positive supply	BMU negative power supply

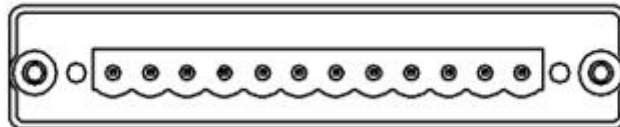

Slave supply		485 communication			CNA2 termination resistance		Display and control communication				
24V+	24V-	485A	485B	GN D	CANR H	CANR L	CAN2 H	CAN2 L	V1+	2 H	2 L

Table 1-10 Definition of external communication terminal (J2)

Pinout	1	2	3	4	5	6
Define	24V+	24V-	A	B	GN D	4:R_2H
Meaning	Power supply to distribution terminal blocks		485 communication		CAN2 termination resistor	
Pinout	7	8	9	10	11	12
Define	14:R_2L	2H	2L	V1+	2H	2L
Meaning	CAN2 termination resistor	Graphic communications		Indicator power supply	Display control communication (reserved port)	

1.4.3 Distribution System

Distribution system consists of air open, terminals, flooding, etc. The AC power supply of the distribution system is divided into two ways, in which the power supply of the water cooler comes directly from the mains; the other AC power supply comes from an external UPS and enters the cabinet to supply auxiliary power to the exhaust fan and the high-voltage box, which can provide DC24V power supply to the cabinet switchboard terminal rows.

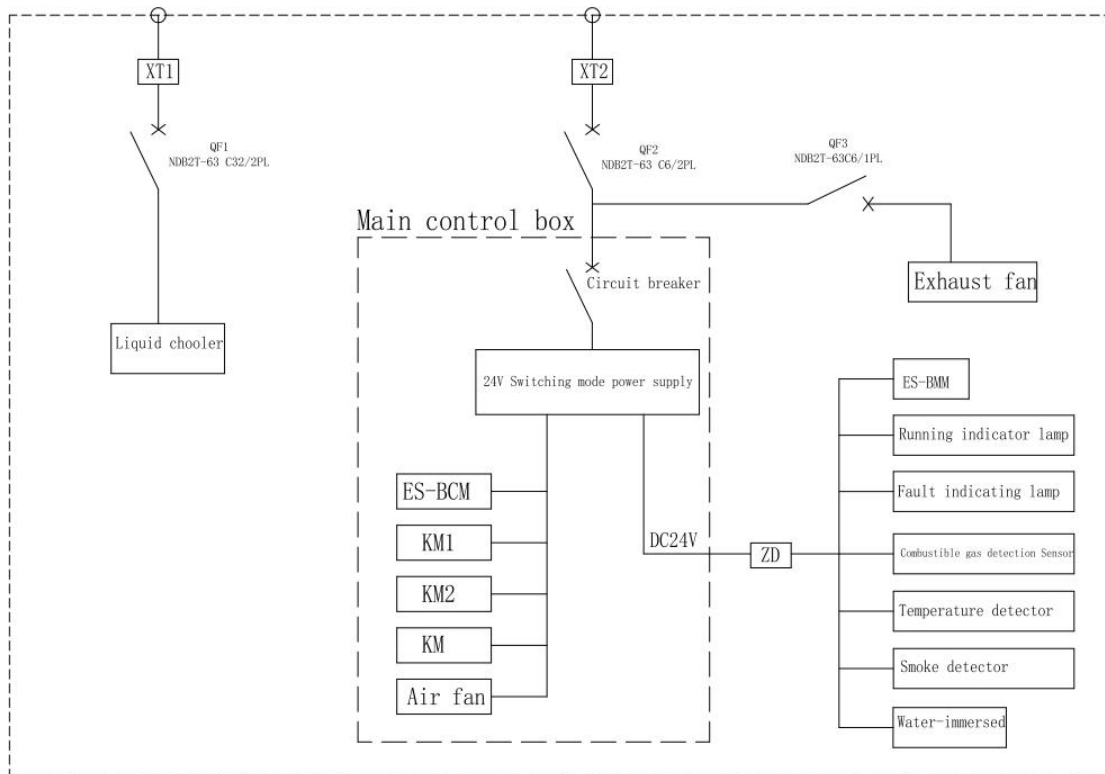

Figure 1-5 Distribution system diagram

1.4.4 Temperature Control Systems

The temperature control system of the outdoor cabinet consists of liquid cooler, water-cooled pipeline, liquid cooling plate, etc. The BMS turns on the functions of refrigeration and heating according to the temperature of the Battery cell it collects and sets the temperature control mode. The default temperature for cooling on and off is 28°C and 22°C; the temperature for heating on and off is 10°C and 15°C.

1.4.5 Fire Extinguishing Systems

The system adopts aerosol as fire extinguishing agent, and the mode is temperature start, when the control box detects the surrounding temperature is higher than 70°C, it will start the aerosol bottle through pulse signal. At the same time, there is a gas detector pre-installed in the cabinet, when the detected combustible gas concentration exceeds the first alarm threshold, it will start the exhaust fan to exhaust; when the detected concentration exceeds the second alarm, or the temperature detector, smoke detector is closed at the same time, or the fire feedback signal, it will shut down the exhaust fan and wait for the aerosol to extinguish the fire.

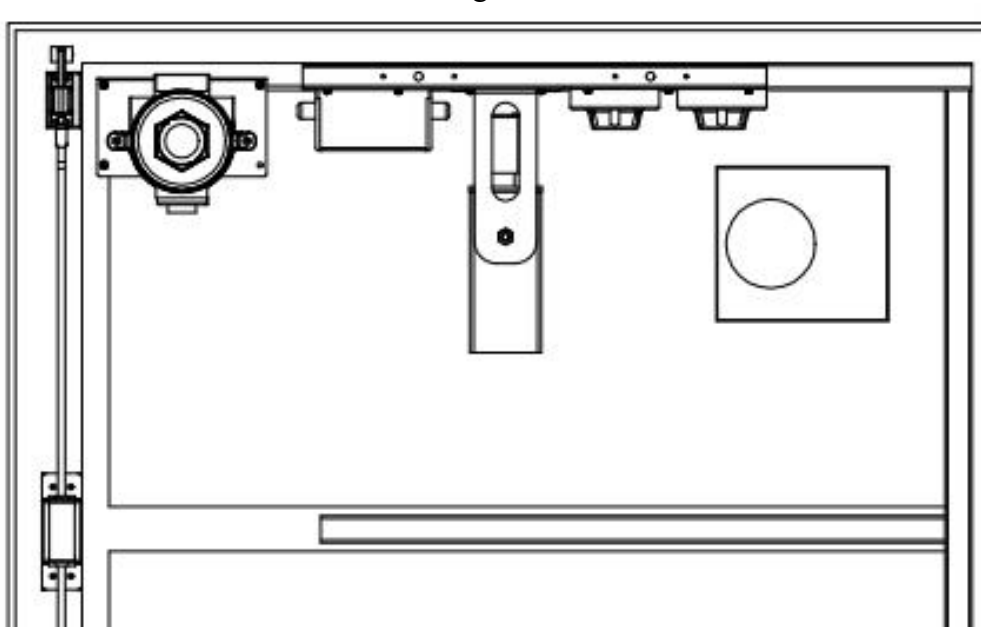

Figure 1-4-5 Fire Extinguishing Systems

1.4.6 Grounding Systems

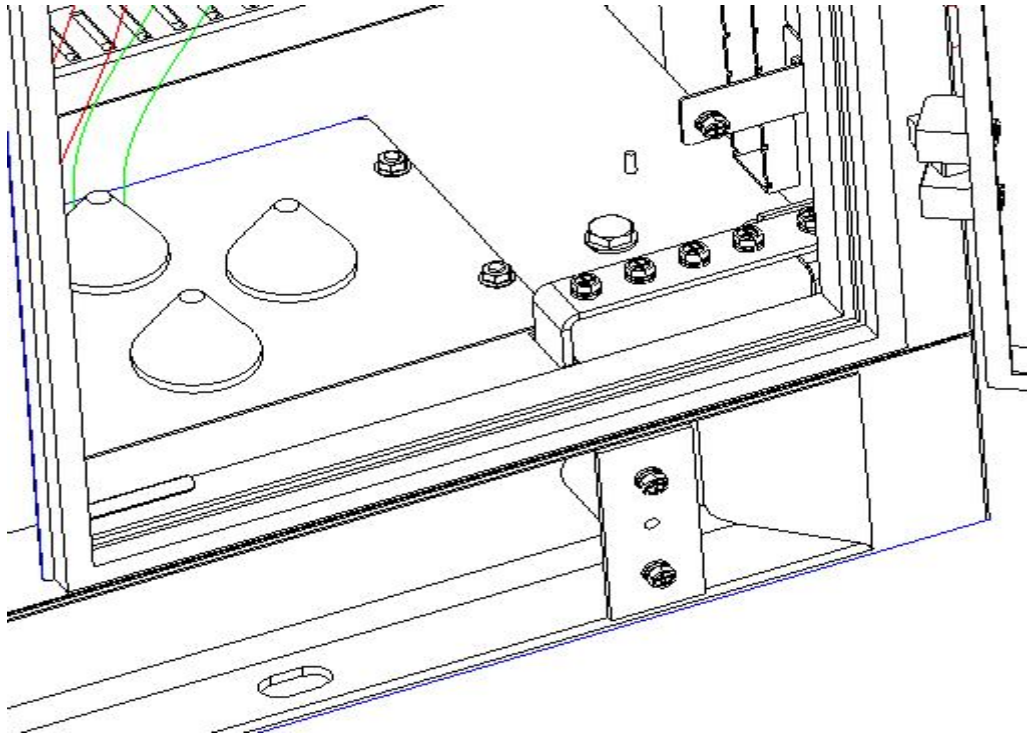
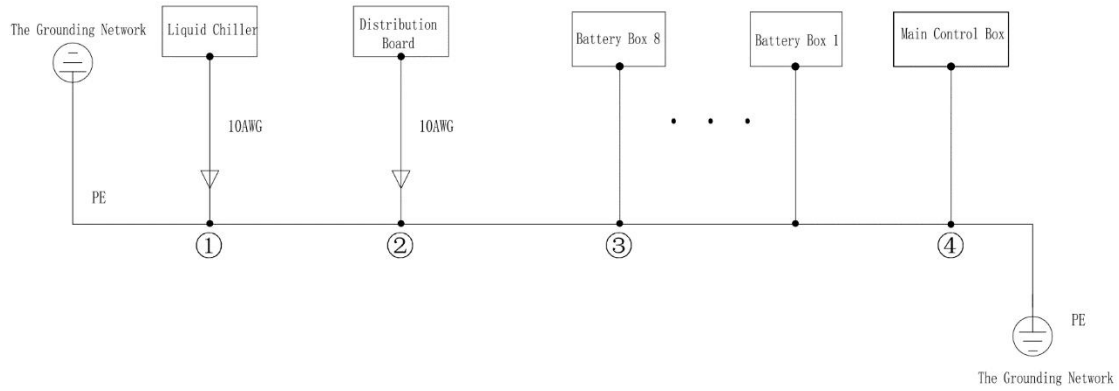

Figure 1-4-6 Grounding schematic

The outdoor cabinet is equipped with two copper grounding points, which are located at the bottom of the outdoor cabinet. The non-functional conductive conductors in the outdoor cabinet that have a direct electrical connection with the communication and monitoring equipment and its mounting base, such as the power distribution equipment, battery box, high-voltage box, liquid cooler and its mounting base, are uniformly connected to the grounding copper row through the internal grounding network.

Chapter II. Installation

2.1 Storage and Transport

2.1.1 Storage

- To avoid condensation on the inside of the outdoor cabinet, it should be stored in a dry warehouse, or failing that, a heater should be provided to keep the internal temperature higher than the outdoor temperature.
- Keep the inside of the outdoor cabinet free from rain and dust and cover the air inlet and outlet with a lid. Avoid opening the case during storage whenever possible.
- The floor on which the boxes are placed must be firm, level, dry and wide. The floor must be able to keep the outdoor cabinet level and free from twisting or crushing. Do not place outdoor cabinet on empty floors as this can lead to scratching and corrosion.

2.1.2 Transport

- The Outdoor cabinet is a cube and can be transported on specialised sea container trucks using a standard container attachment system.
- If a specialised sea container trailer is not used, place the outdoor cabinets on a transport low shelf to prevent slipping and keep them as short as possible. Place friction-enhancing pads underneath the container, with a maximum thickness of 3cm, and secure the container to the underframe with tough transport straps.

2.1.3 Outdoor Cabinet Integrity Checks

When the outdoor cabinet arrives at the project site, the system should be checked for integrity.

- External inspection: six-sided inspection of the box, check the external are damaged, deformed, broken and other abnormalities, if any, that is, to make the repair part of the sign.
- Internal inspection: The inside of the box is inspected on all six sides to check for leaks, light leaks, stains, water stains, etc.
- Equipment-level installation checks: check for displacement of fire protection systems, monitoring cabinets, battery racks, battery boxes, air conditioning, PCS, and AC power distribution cabinet installation locations.



Figure 2-1 Cabinet outer packaging











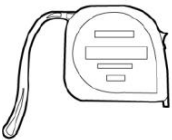

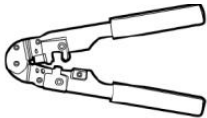

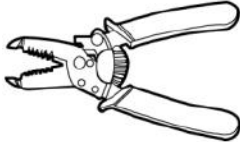
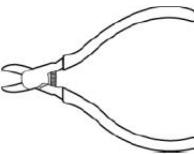

Figure 2-2 Cabinet appearance

2.2 Mechanical Installation

2.2.1 General Requirements

2.2.1.1 Tool Preparation

Table 2-1 Installation tool list

Lift trolley	Phillips screwdriver	One-sided screwdriver	Insulated adjustable spanner
			
Multimeter	Insulated protective shoes	Insulating tape	Insulated gloves
			
Steel tape measure	Socket wrenches	Crystal head crimping pliers	Marker pen
			
Wire stripper	Tweezers	Utility knife	Crimper
			

2.2.1.2 Environmental Requirements

Table 2-2 Installation conditions

Installation conditions	Static fixed installation
Installation site requirements	The unit is mounted outdoors on a concrete base, or a countertop that can provide a similar base. The mounting surface is required to be firm and level
Under attack	No shocks during installation
Free-fall	No free fall during installation

2.2.1.3 Foundation Requirements

Civil foundation requirements for the energy storage system: foundation load-bearing capacity of not less than 5 tonnes.

2.2.2 Box Installation

Foundation: The design and construction of the foundation of the energy storage outdoor cabinet at the customer's site should be in line with our foundation schematic illustration diagram, pay attention to the Q235 steel plate pre-embedded, chiller air supply duct, steel ladder pre-embedded, draw the outdoor cabinet seating line on the upper surface of the foundation, and clearly mark the direction of the battery compartment, PCS compartment end marking, as shown in Figure 2-3 below.

The Q235 steel plate pre-embedded (100*50*15)
Flush with cement foundation

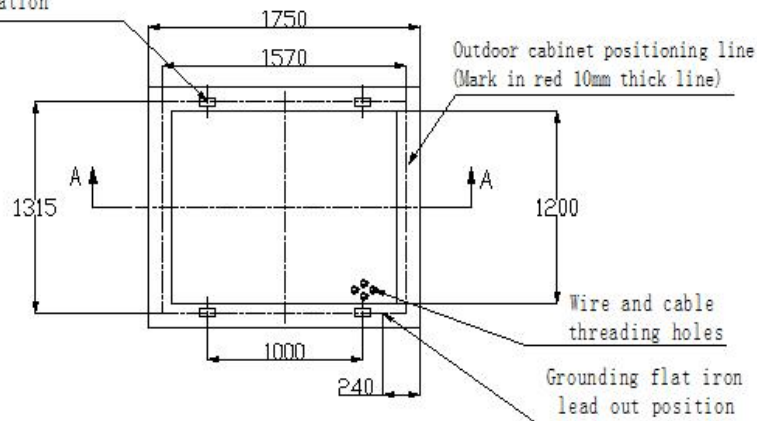

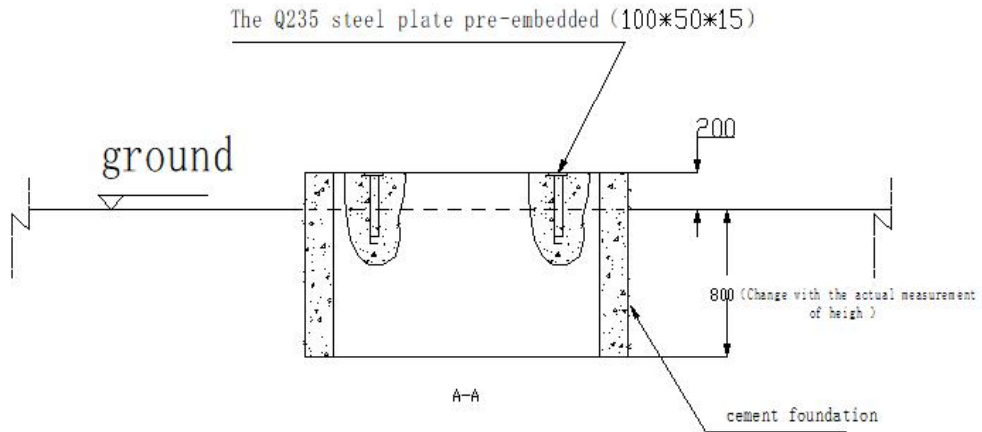

Figure 2-3 Schematic diagram of site foundation

Placement: the energy storage cabinet is marked according to the above tips, the battery compartment maintenance door is aligned with the battery compartment staircase, the outer edge line of the energy storage cabinet coincides with the above contour line, the bottom beam of the energy storage cabinet is welded to the pre-embedded Q235 pads in combination with the corners.

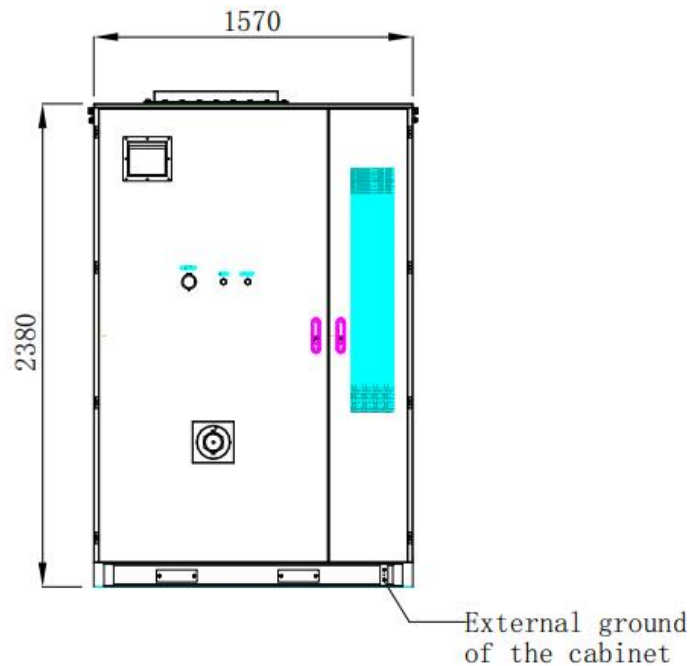

Figure 2-4 Outdoor cabinet front view

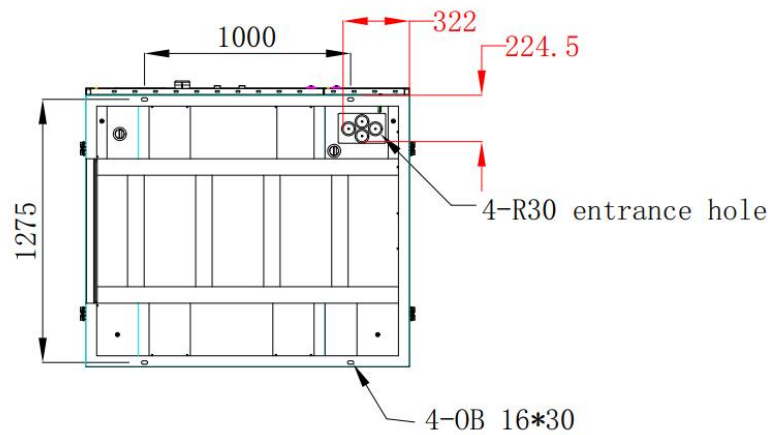

Figure 2-5 Outdoor cabinet bottom view

2.3 Electrical Installation

Installation Precautions

In order to ensure the life safety of the installer, the necessary safety precautions must be taken when carrying out the electrical installation of this product. The following procedures must be observed when performing electrical installation:

- All power sources connected to the outdoor cabinet must be disconnected to ensure that the outdoor cabinet is in a non-powered state.
- A warning sign must be left at the disconnected location to prevent it from being re-energised during installation.
- Necessary grounding and short-circuit connections are required.
- Electrically charged parts need to be treated as necessary and isolated with insulating material to avoid injury to personnel.
- After the PACK is removed, cover the unused pole with the pole plastic sleeve until it is rewired.
- Professionals are required to install and operate the outdoor cabinets, and the installation process is carried out in strict accordance with the instructions in the user's manual.
- The installer must comply with the relevant electrical operating regulations of the country or region in which he is working.

2.3.1 Cable Routing Requirements

When laying cables, communication lines and power lines should be laid separately, DC and AC circuits should be laid separately, and the distance between different cables should be more than 300mm.

When control cables must be routed through power cables, ensure that the angle between the two cables is kept as straight as possible.

2.3.2 Cable Fixing and Protection

2.3.2.1 Cable Fixing

In order to prevent the cable and terminal from loosening or contact resistance from becoming large and causing heat or even fire, when tightening the screws of the terminal lugs, the tightening torque should meet the following requirements:

Table 2-3 Torque table (Unit: N.m)

Bolt	Torsion	Bolt	Torsion
M3	0.7~1	M8	18~23
M4	1.8~2.4	M10	34~40
M5	4~4.8	M12	60~70
M6	7~8	M16	119~140

Note: Ensure that the cable is in the proper place to reduce strain on the cable lugs.

2.3.2.2 Protective Cables

The cables have to meet the voltage insulation level and have to be protected from scratches and damage to the cable insulation. This includes protection of power cables and communication cables. The measures are as follows:

Power cable protection: To prevent short-circuiting, the cable insulation must not be scratched during installation and connection, and the cable must be properly secured after wiring.

Communication cable protection: It is recommended to complete the power circuit wiring first, and then try to take the way to connect the communication cables in the way of the wire groove, without the groove using a tie for fastening, avoiding the heat element and strong electric circuit cable when the line.

2.3.2.3 Cable Selection

Users in the configuration of the cable according to Table 2-4 specifications for optional.

Table 2-4 Cable specifications

Cable wiring location	Maximum voltage and current	Number of screw holes	Hole diameter (mm)	Cable recommendations	Cable terminal selection	Note
Auxiliary distribution box	Voltage: 400VAC Current: 125A	4	Φ10	35-100 mm ² cable	OT terminal 35-10	Customer choice
DC convergence cabinet	Voltage: 400VAC Current: 1000A	6	Φ12	150mm ² cable	OT terminal 150-10	Customer choice
Communication line	--		--	Network cable	Crystal head	

Note [1]: This table is recommended for insulated copper-core cables. If other types of cables are used, they should be configured with reference to the local wiring regulations, the specific application environment (temperature and physical support media, etc.) and the requirements in IEC62109-1 Table24.

Note [2]: Terminal selection needs to be matched with the cable. The selection in the table corresponds to the recommended cable, if you do not choose the recommended cable, the user needs to choose another suitable terminal.

2.3.3 Outdoor Cabinet Wiring

The wiring of the outdoor cabinet is divided into 4 parts, namely DC power cable wiring, AC power cable wiring, communication line wiring, and grounding. For safety reasons, all electrically charged parts of the outdoor cabinet are covered with protective plates, which cannot be touched by human hands. The protective plate needs to be removed with tools before wiring. After removing the protective plate, the terminals and copper rows are exposed, and the wires are connected in accordance with the marking and the required specifications.

2.3.3.1 DC Power Cable Wiring in Outdoor Cabinet



Figure 2-6 Power cable wiring diagram

- 1、 the battery box from top to bottom, numbered 1 ~ 8, the power cable in accordance with the main control box negative (B-) start to the battery box 1 negative, battery box 1 positive to the battery box 2 negative, until the battery box 8 positive; and then from the battery box 8 positive connected to the main control box positive (B+). During the connection process, only one cable can be connected at a time to prevent accidental short-circuiting during operation.
- 2、 On the left side of the main control box panel, the positive cable connects the positive pole of the PCS and the positive pole of the output of the main control box (P+); the negative cable connects the negative pole of the PCS and the negative pole of the output of the main control box (P-).
- 3、 After the connection is made, check that the quick plug of the power cord is locked in place.

Note: All power connectors in the outdoor cabinet are in quick-plug form, when the plug is inserted into the socket, a clear feedback sound of quick-plug can be heard at the moment of locking, observing the locking key on the side of the quick-plug, the locking key can be seen on the plane bouncing back to the horizontal position. Battery connections must be made sequentially from negative to positive, not starting at the positive and negative ends and ending in the middle.

2.3.3.2 Ground Wire

Outdoor cabinets are equipped with 2AWG grounding wire as standard, and there is a grounding hole under each cabinet, which connects the outdoor cabinets to the grounding row of the convergence cabinet and then to the grounding system through the grounding wire.

Ground screw: Cross recessed countersunk combination screw GB/T9074.13-M6*16 304 stainless steel. Qty: 2PCS

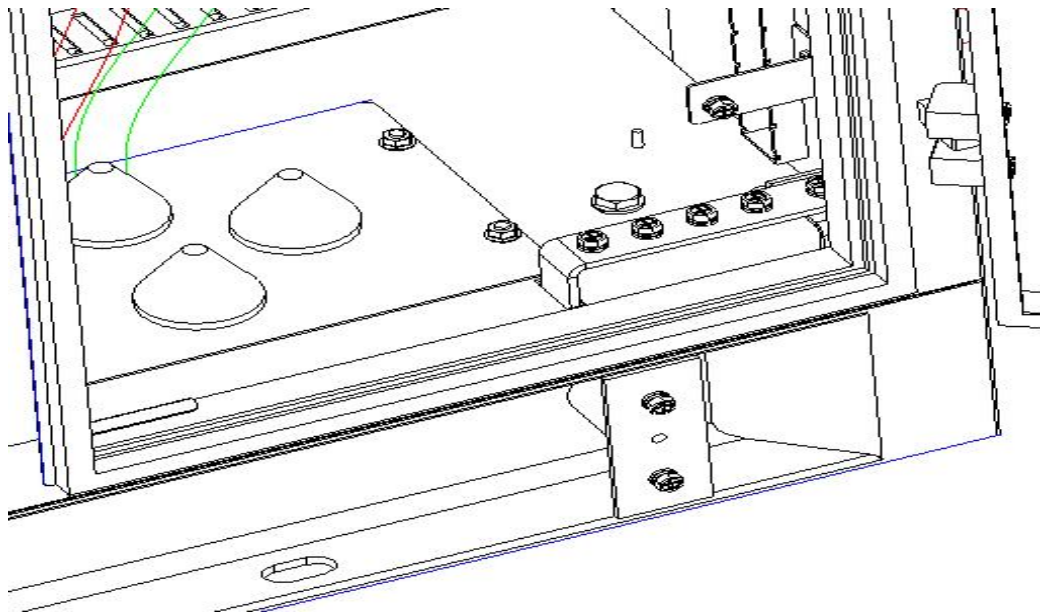

Figure 2-7 External grounding copper



Warning

The grounding cable must be well grounded, otherwise the following hazards apply:

In the event of a malfunction, there is a risk of fatal electric shock to the operator!

May result in equipment damage in the event of a lightning strike!

It may cause the device to fail to operate properly!



Attention

Grounding connections must comply with the grounding standards and codes of the country where the project is located.

Grounding connections to both the equipment and the earth electrode must be tight and reliable.

Grounding resistance shall be measured after the grounding is completed, and the resistance value from the grounding row of the outdoor cabinet to the grounding pole shall not be greater than 0.1Ω .

The equipment in the outdoor cabinet is connected to the main grounding strip in the outdoor cabinet.

2.3.3.3 AC Distribution Cable Wiring

AC auxiliary power supply cable wiring channel at the bottom of the outdoor cabinet, external single-phase AC power into the outdoor cabinet, connected to the XT1 adapter terminal block, used to supply power to the liquid cooling machine; external single-phase AC power output from the UPS, into the outdoor cabinet, connected to the XT2 distribution terminal, used to monitor the power supply of the equipment (high-voltage box, exhaust fan).

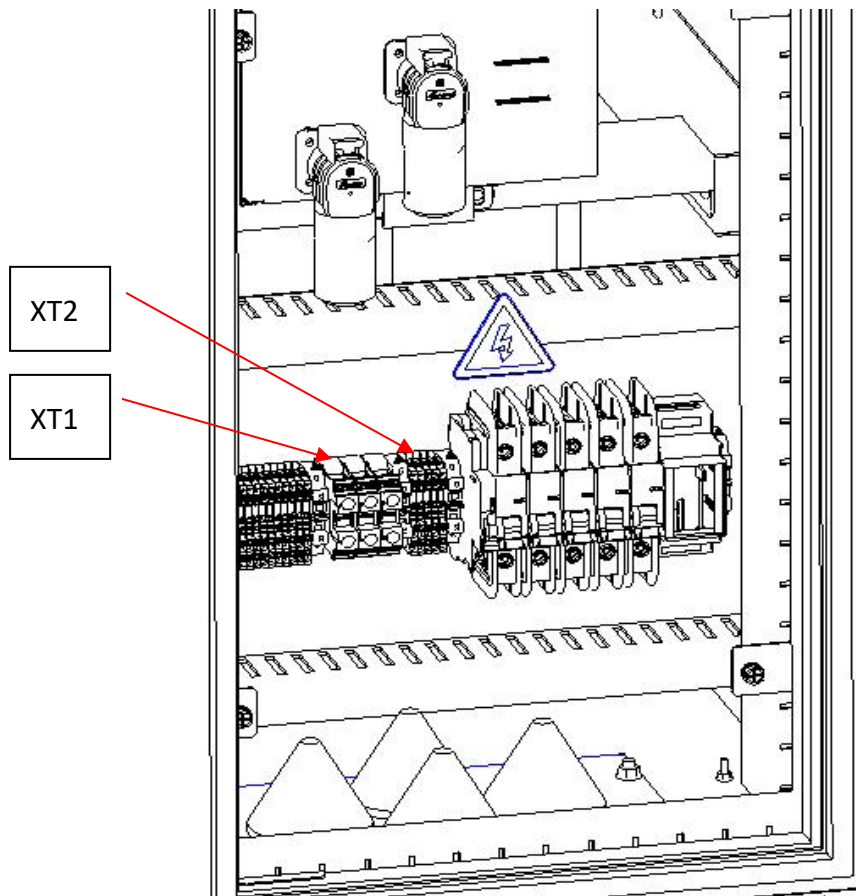

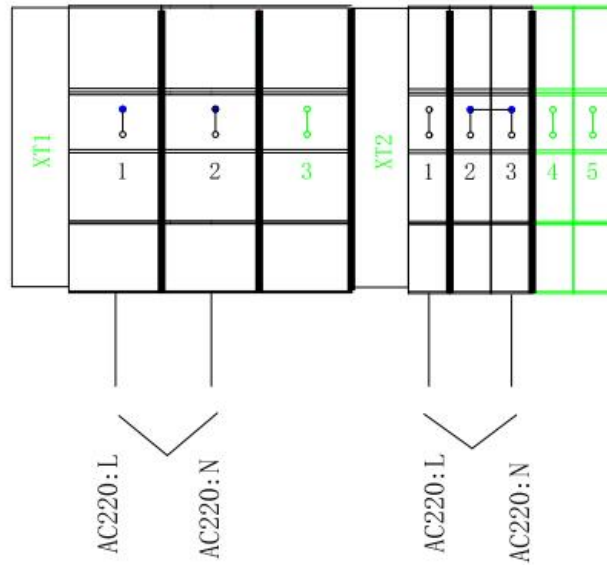

Come from combiner cabinet AC220V Come from combiner cabinet UPS

Figure 2- 8 AC inlet terminal block

Serial number	Pin	Definition	Wiring Description
1	XT1:1-2	L	L to external AC220V (sink cabinet)
2	XT1:2-2	N	N to external AC220V (sink cabinet)
3	XT2:1-2	L	L to external UPS output (sink cabinet)
4	XT2:2-2/3-2	N	N to external UPS output (sink cabinet)

2.3.3.4 Communication Cable Wiring

Outdoor cabinet to the convergence cabinet communication using RVSP shielded twisted-pair cable, outdoor cabinet signal terminal block is defined as follows:

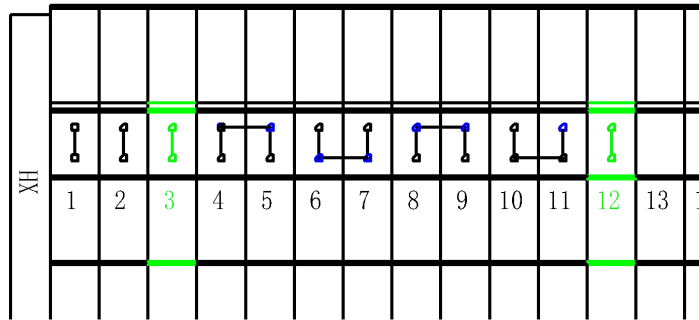

Figure 2-9 External communication terminal block

Serial number	Pin	Definition	Wiring Description
1	XH:1-2	CANH	Connects to the CANH of an external ESMU
2	XH:2-2	CANL	CANL connected to external ESMU (display control)
3	XH:3-2	CANG	Connecting shield of shielded twisted pair cable

2.3.4 Electrical Installation Completion Inspection

After the installation is complete, the following must be reconfirmed and measured in order to avoid damage to the equipment and loss of property:

- Disconnect all circuit breakers in the switchboard before measuring.
- Confirm that the positive and negative connections of the DC side battery array are correct and have been tightened. Measure the resistance of the DC positive and negative terminals, normally it should be megohm resistance, if it is K or less need to check the connecting wire.
- Verify that the grounding and communication wires are tightened.
- Verify that the earth wire resistance is less than 0.1 ohm.
- Once the installation is complete, reinstall all protective baffles that were previously removed.

- Clean up the installation area and verify that no tools or foreign objects are left in the installation area.



Warnings

The removed lower baffle needs to be reinstalled, this baffle blocks foreign objects from entering the equipment, if not installed there is a danger of foreign objects entering.

It is strictly forbidden to switch on the machine without installing protective baffles.

After all electrical wiring is completed, the wiring should be thoroughly and carefully checked to confirm that it is correct, adjust the cables to the appropriate position, install the baffle plate, and fix the cables to the cable tie bridge with cable ties, and seal the gap part of the cabinet inlet hole with fireproof mud to prevent small animals from entering the machine.

Chapter III. Operation

3.1 Preparation for Start-up

To ensure the safety of the outdoor cabinet, the following items must be checked before the first power-up or the first power-up after maintenance:

Table 3-1 Inspection item

Sequences	Inspection items	Completion
1	Permitted installation and runtime environments.	
2	Outdoor cabinets correctly fixed to the foundation.	
3	Proper grounding of outdoor cabinets.	
4	Each equipment grounding copper, DC positive and negative copper, AC side copper, external power supply copper correctly connected, tightened and safe.	
5	Cable gutter supports are well installed and cable routing meets requirements.	
6	Cabinet is free of tools, external objects and drilling debris left inside the cabinet.	
7	Correct positive and negative polarity.	
8	AC phase sequence is connected correctly.	
9	Check that the cables are not torn or scratched and that the filters in the vents are intact.	
10	The circuit breakers on the AC and DC sides have been disconnected, and the external auxiliary power supply switches have been disconnected, i.e. they are all in the "OFF" position.	
11	The internal baffles have all been installed.	
12	All equipment covers are in place.	
13	All auxiliary safety devices have been installed (fire protection, temperature control system) and are functioning properly. All alarm devices have been installed.	

3.2 Operating Instructions

3.2.1 Operating Instructions for the HVDC Section

Before operation and maintenance/connection of power lines, it is necessary to check the status of the disconnecting switch and make sure that the disconnecting switch of the high-voltage box is in the "OFF" state. After all cables are connected reliably and the power lines outside the cabinet are connected, when it is necessary to power up and run, first rotate the isolating switch of the high-voltage box from the "OFF" to the "ON" position, and close the manual breakpoint on the DC side, as shown as

following figure.

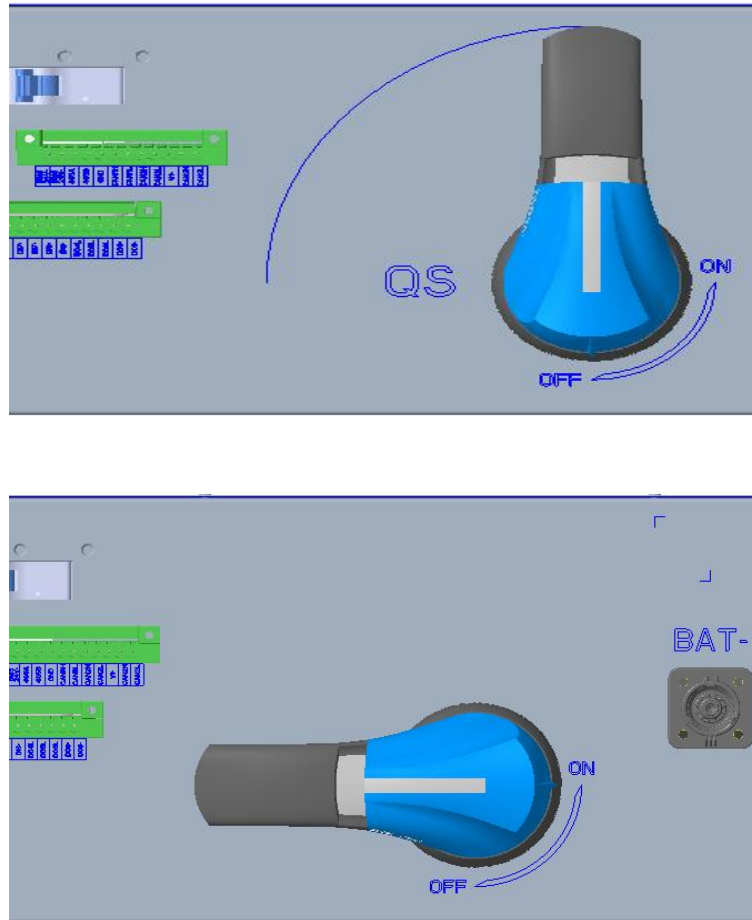

Table 3-2-1 Inspection item

3.2.2 Operating Instructions for the Power Distribution Section

The layout of the switchboard is as shown in the figure below, with DC distribution terminals, signal transfer terminals, AC transfer terminals for the liquid cooler, and AC distribution terminals for power supply to BMS and other monitoring equipment.

QF1, as shown below, is the switch used to supply power to the liquid cooler, QF2 is the master switch used to supply power to the monitoring equipment, and QF3 is the switch used to supply power to the exhaust fan.

When powering up the system, close QF1 to supply power to the liquid cooler; after closing QF2, then close the air switch on the high-voltage box, then the BMS in the outdoor cabinet will start and self-check, when the self-check is correct, it will close the main relay in the high-voltage box, and the high-voltage powering up is ready; if QF3 is closed, then the exhaust fan will be ready, and it can be started and stopped according to the status of the dry contact of the BMS. When the outdoor cabinet is ready for power-up, the operation indicator of the cabinet door will be lit.

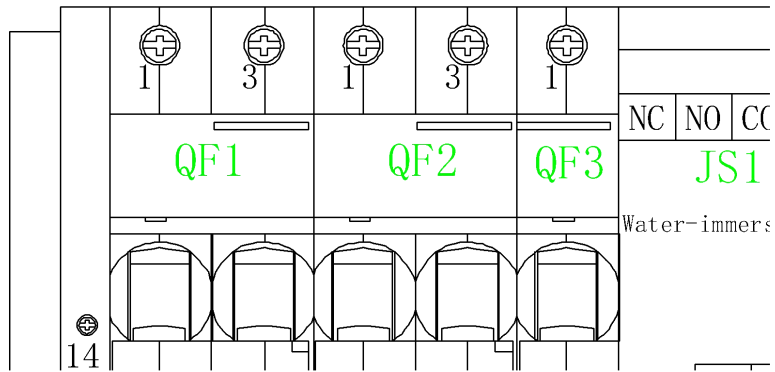

Figure 3-1 Switchboard distribution section

3.2.3 Operating Instructions for the Water Cooler

This section is detailed in the Water Cooler Owner's Manual.

3.2.4 Description of the Fire Protection System

The outdoor cabinet adopts aerosol as the fire extinguishing agent, and a separate fire control box detects the temperature inside the cabinet and starts the aerosol bottle to spray aerosol to extinguish the fire when the starting condition is reached.

3.2.5 Local Monitoring Operation Description

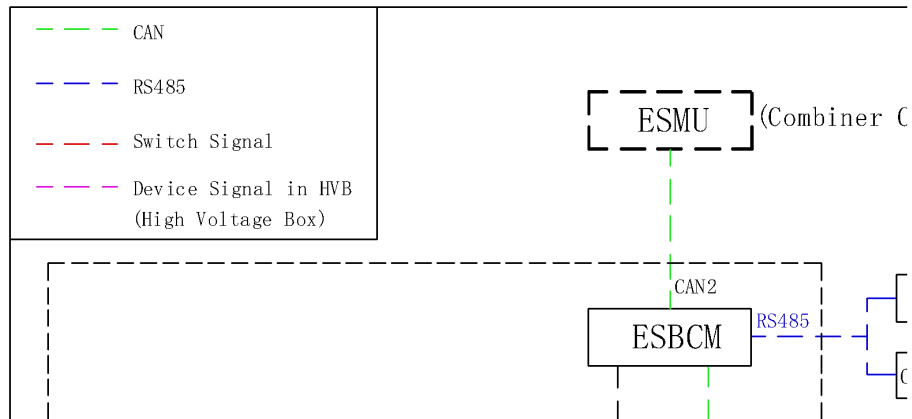

Table 3-2 List of major communications equipment

Equipment name	Specification description	Unit	Quantities
Liquid cooling units	EMW90HDNC1A	pcs	1
Combustible gas detectors	Xgard-Bright-GZ-H-02	pcs	1
ESBMM	ESBMM-2412-F	pcs	16
ESMU	HV:2.0.0 (In busbar)	pcs	1

BSBCM can collect information on access control, flooding, fire protection, switching status, etc. through DI interface; ESBCM collects information of ESBMM through CAN communication and communicates with ESMU in the external convergence cabinet through CAN communication; Liquid cooler and combustible gas achieve data interaction with ESBCM through RS485, and ESBCM controls the battery information and the ESBCM controls the operation mode of the liquid cooler according to the battery information collected by the ESBMM.

3.3 Power-up Procedure

- Step 1: Confirm that the wiring on the side of the external convergence cabinet is correct and that the outdoor cabinet has the conditions for powering up.
- Step 2: Close the disconnecting switch of the main control box to change from OFF state to ON state.
- Step 3: Close the control power micro-break QF on the main control box, and the switch changes from OFF state to ON state.
- Step 4: Close the 3 micro-terminals QF1, QF2 and QF3 in the switchboard position so that the switches all change from OFF to ON.
- Step 5: Check the status indicator on the door of the outdoor cabinet. After the system is powered up and self-tested correctly, the operation indicator will be lit automatically and the outdoor cabinet will enter the ready state.

Note: The fire protection system and the liquid cooling system are not allowed to be disconnected during the operation status. If a problem occurs at a step during operation, stop immediately and check the status of each device.

3.4 Downtime Procedures

3.4.1 Normal Shutdown Procedure

- Step 1: Stop charging and discharging of the outdoor cabinet by external equipment and ensure that the outdoor cabinet is in a static state.
- Step 2: Disconnect the micro terminals QF1~QF3 at the switchboard in turn.
- Step 3: Disconnect the main control box control power micro break QF.
- Step 5: Disconnect the main control box load disconnect switch.

3.4.2 Emergency Shutdown Procedures

In the event of an emergency, press the emergency stop button on the door of the outdoor cabinet, and the primary circuit inside the outdoor cabinet will immediately cut off and stop the charging and discharging path.

Note: This fault needs to be cleared manually on the BSMU touchscreen before the system will start again.

Chapter IV Product Maintenance

Due to factors such as ambient temperature, humidity, dust, and vibration, the internal components of an energy storage system are subject to aging and wear and tear, which can lead to potential failures inherent in the energy storage system. Therefore, it is necessary to perform routine and periodic maintenance on the energy storage system to ensure its normal operation and service life.

All measures and approaches that help to keep the energy storage system in good working order are within the scope of maintenance.

4.1 Maintenance of Security Matters

When performing maintenance or overhaul of the energy storage system, etc., be sure to observe the following safety rules to ensure the safety of the operator:

- Only authorised personnel may carry out maintenance tasks. Wear protective equipment (face shield, gloves, boots, arc protection suit, etc.) before carrying out work.
- Disconnect all external connections to the energy storage system and to the internal power supply of the unit.
- Ensure that the energy storage system is not accidentally re-powered.
- Use a multimeter to ensure that the inside of the energy storage system has been completely de-energised.
- Make the necessary grounding and short-circuit connections.
- Insulate and cover the temporary potentially live parts of the operating section with fabric made of insulating material.

4.2 Maintenance Work and Cycles

4.2.1 Battery System Maintenance

Table 4-1 Battery System Maintenance Schedule

Inspection content	Inspection methods	Maintenance cycle
Sweep	Sweep the system enclosure to ensure that it is free from birds, animals, pests, rubbish, etc.	every month
Safety Isolation device	Ensure that such devices operate within the limits of their ratings.	1 per year
Cord	No damage to cables visually	every month
Warning labels, nameplates	Visual warning labels, nameplates in place	every month
Louvre	Visually check that all ventilation holes are	every month

	clear	
Battery health status	Check if the battery system SOH is normal via ESMU	every month
Operating state	Audit the system log, the system should work without anomalies	every month
System voltage	System DC side voltage is in the normal range	every month
System terminal	No corrosion, no visible discolouration, no loosening	every month
Appearance, temperature	The battery system was checked through the BSMU and there was no distortion of the modules and no significant over-temperature.	every month
Earth	Use a multimeter to test for good contact from the bare metal of the battery box to the battery box ground point.	1 time every 6 months

4.2.2 Battery Box Maintenance

Note: The battery compartment must be disassembled with all auxiliary and power switches disconnected.

The battery box is removed and installed as follows:

Tools: Lifting trailer (load capacity over 400kg, lifting height 2.5m), φ6 socket, Phillips screwdriver.



Figure 4-1 Exterior view of the battery box

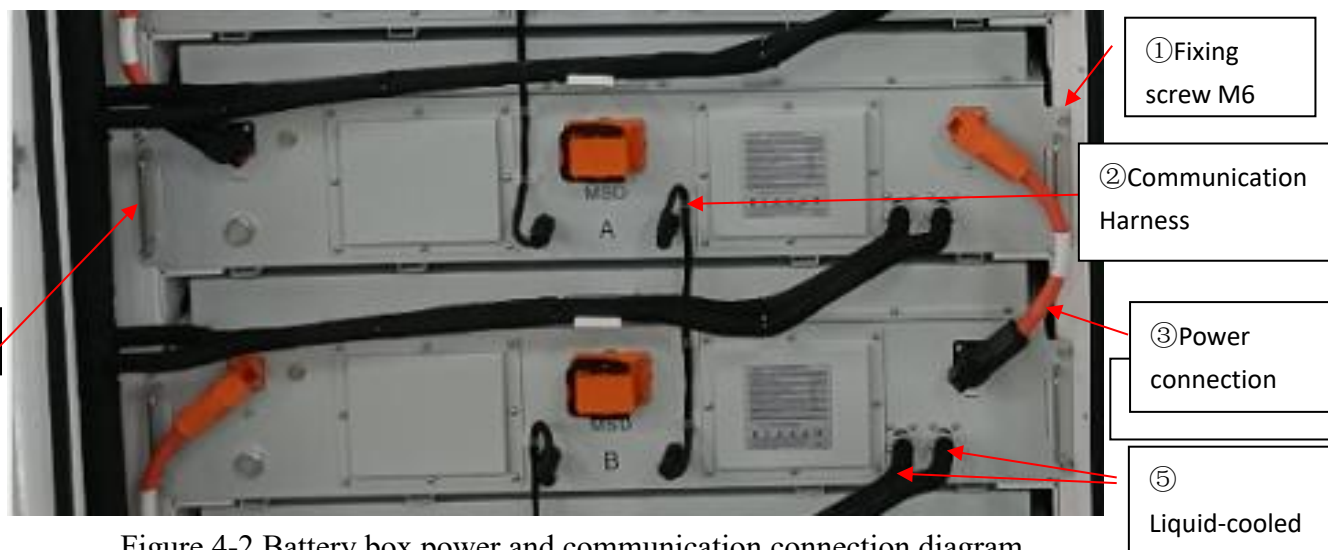

Figure 4-2 Battery box power and communication connection diagram

- 1、 Drain the antifreeze from the liquid-cooling pipe after power failure.
- 2、 Remove the liquid-cooling tubes⑤ from the top and bottom of the battery pack to be removed.
- 3、 Remove the battery box external communication harness ②.
- 4、 Remove the battery box external power harness ③.
- 5、 Remove the four ①M6 Phillips hexagon socket combination screws from the battery box with $\phi 6$ socket.
- 6、 Pull out the battery box (326kg), pull the metal handles at both ends of the battery box and the bottom, lift the battery box out to the trailer and transport it to the warehouse for proper storage.

The battery box installation process is as follows:

- 1、 Place the battery box on the trailer and push the trailer under the battery box to be replaced.
- 2、 Multiple people lift the battery box, hand carry the battery box ④ metal handle, push the battery box to the battery rack.
- 3、 Adjust the $\phi 6$ sleeve torque to 5N-m and screw on the four ①M6 cross socket combination screws in turn.
- 4、 Connect the power harness according to the wiring diagram ③.
- 5、 Clean up the site and organise tools.
- 6、 Recommended routine maintenance intervals and work are shown in Table 4-2 below.

Table 4-2 Battery box maintenance

Inspection content	Inspection methods	Maintenance cycle
Fan	Temperature sampling of the battery box is observed through the monitoring system.	every month
Sweeping module	Module free of foreign matter	every month
Exterior inspection	No deformation of the module, no liquid leakage	every month
Connection of cells or modules	Check the internal voltage and insulation of the module by EMS.	every month
Earth	Use a multimeter to test for good contact from the bare metal of the battery box to the battery box ground point.	1 time per year

4.2.3 Main control Box Maintenance

Note: The main control box should always be disassembled with all auxiliary power supply switches and power switches disconnected.

The main control box is removed and installed as follows:

Tools: Lifting trailer (load capacity over 50kg, lifting height 2.5m), $\phi 8$ socket, Phillips screwdriver.

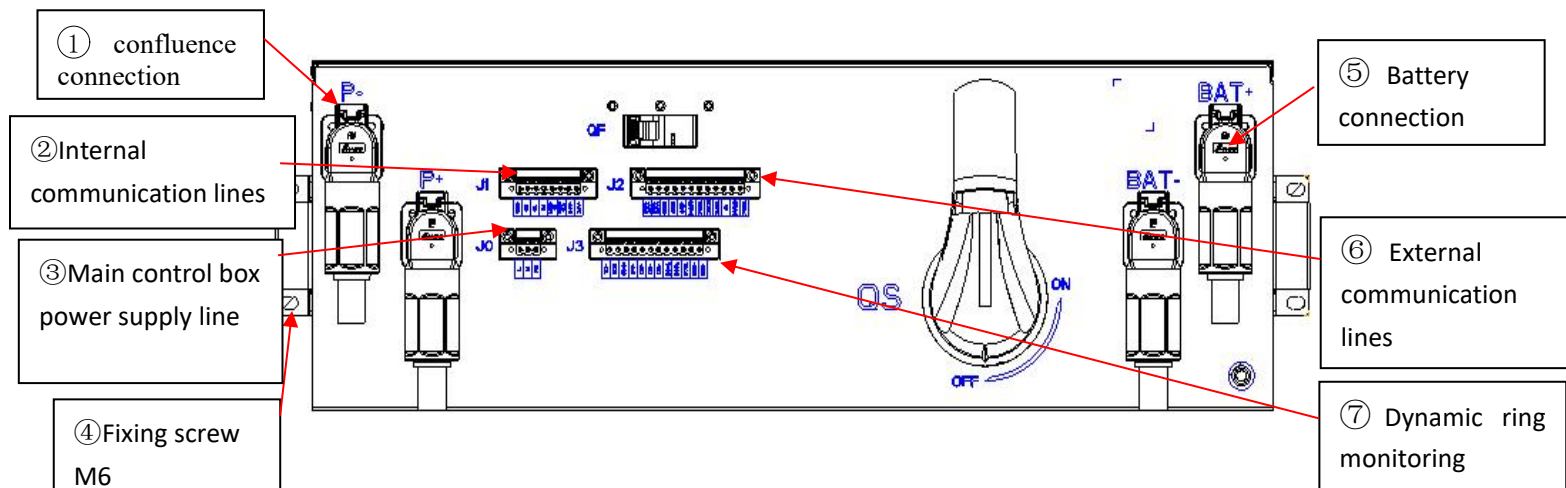

Figure 4-3 Schematic diagram of main control box removal

- 1、 Remove the main control box communication harness ②, ③, ⑥ and ⑦;
- 2、 Remove the power line ① from the main control box box to the convergence cabinet.
- 3、 Remove the power line from the battery box to the main control box ⑤.
- 4、 Use a Phillips screwdriver to remove the four ④ Phillips combination screws of the main control box.
- 5、 Push the lifting trailer under the battery box, pull out the main control box to the trailer and transport it to the warehouse for proper storage.

The procedure for installing the main control box is as follows:

- 1、 Place the master control box on the trailer and push the trailer under the master control box to be replaced.
- 2、 Raise the lift trailer to a suitable position and push the main control box by hand to the battery rack.
- 3、 Use a Phillips screwdriver to screw on the 4 ④ Phillips combination screws of the main control box.
- 4、 Connect the power cable ⑤ from the battery box to the main control box.
- 5、 Connect the power line ① from the main control box to the convergence cabinet.
- 6、 Connect the main control box communication harness ②, ③, ⑥ and ⑦.
- 7、 Clean up the site and organise the tools.

Recommended routine maintenance intervals and work are shown in Table 4-3 below.

Table 4-3 Main control box maintenance

Inspection content	Inspection methods	Maintenance cycle
Exterior condition	The surface has no traces of rust, deformation, dirt, pulling arc and so on.	every month
Newsletter	Observe whether the parameters of the main control box are normal through the monitoring system.	everyday
Earth	Use a multimeter to test for good contact from the bare metal of the battery box to the battery box ground point.	1 time per year

4.2.4 Maintenance of Water Coolers

Repair and maintenance of the unit

Maintenance can be divided into two categories: general maintenance and preventive maintenance. General maintenance consists of routine inspections, which can be carried out by the user's general staff, but preventive maintenance must be carried out by professionally competent maintenance personnel who are familiar with air-conditioning units, cooling and cutting systems, electrical and electronic equipment.

Maintenance of water pump compressors

Water pump, compressor as an important part of the refrigeration circulatory system, routine maintenance is particularly important. Part of the heat of the water pump depends on the cold water cycle for heat exchange, part of the use of the motor tail fan for heat dissipation. Regular time to check the water pump motor, compressor surface whether there is dust accumulation with a clean rag and blowing device to remove dust.

Condenser cleaning

As the outdoor environment contains more dust in the air, adsorption in the cooling surface will affect the cooling effect, resulting in refrigeration system can't work properly or even high pressure alarm. Especially in summer when the outdoor temperature is high, the condenser should be cleaned frequently. In the cleaning should pay attention to the condenser fins can't be damaged, the direction of water rinse and air flow should be reversed.

Calibration of high and low voltage protection value devices

In the refrigeration system, high and low pressure protection is an essential device. Usually high pressure setting value in 40Bar or so, low pressure protection value in 6Bar or so, in the system pressure exceeds the standard, the protector began to work, so as to avoid damage to the compressor, due to the device for the control of the instrument there is a certain error. So the requirement of an annual calibration. This is to use the duplex pressure gauge such as high precision test instrument to calibrate. In the test, usually in the system to create artificial high pressure and low pressure, and then against the scale of the duplex pressure gauge indication, to calibrate the set value of high and low pressure protection.

Temperature and Humidity Sensor Setting and Calibration

The temperature and humidity sensors are correctly adjusted at the factory. In case of abnormal conditions and unstable power supply, deviations may occur, which need to be corrected in time. When the normal temperature and humidity are different from the actual situation, an accurate standard thermometer should be prepared and used as a reference for calibration.

Caveats:

- Do not use this product in flammable or explosive environments.
- Ensure that the unit condenser inlet and outlet air is clear.
- Do not switch on and off the unit too often, as the unit may be damaged by frequent start-ups.

- Users should not repair the unit by themselves, if the repair is not done properly, it will cause the unit to malfunction or burn out. If you need to repair, please contact the dealer or manufacturer.

⚠Warnings

- Do not insert your fingers or anything else into the condenser air outlet or air inlet to avoid injury or damage to the unit.
- Do not damage the power cord or control sensor cable, and do not unplug or plug in the power cord to switch the unit on or off.

The recommended routine maintenance intervals and work are shown in Table 4-4 below:

Table 4-4 Water cooler maintenance

Inspection content	Inspection methods	Maintenance cycle
Electrical control section	Calibration Temperature, Pressure Sensors. Check equipment protective earthing. Calibration of instruments, meters, clocks.	1 time per year 1 time per year 1 time per year
Air handling section	Check the rotation of the fan, the fan impeller has no deformation. Clean or replace air filters. Check that water inlet and drain valves and drain pipes are clear. Check for running, bubbling and leaking air.	1 time per quarter 1 time per month 1 time per month 1 time per month
Compressor section	Check suction and discharge pressures and for overcooling and overheating. Check refrigerant tube fixing. Check compressor suction and discharge valve ports for leakage.	1 time per quarter 1 time per year 1 time per quarter
Other components	Cleaning of grey layer and dirt on the surface of the equipment. Check and clean condenser fins. Check fan motor support and blades. Check fan motor bearings and lubricate regularly. Check fan speed regulation and F.V.S setting.	1 time per month 1 time per quarter 1 time per quarter 1 time per quarter 1 time per quarter

4.2.5 Maintenance of Fire Protection Systems

The recommended routine maintenance intervals and work are shown in Table 4-5 below:

Table 4-5 Fire Protection System Maintenance

Inspection content	Inspection methods	Maintenance cycle
Temperature and smoke sensors	Close the fire tank and check that the temperature and smoke sensors are working.	1 time per year
Combustible gas detection	Close the fire tank and check for proper combustible gas detection.	1 time per year
Battery replacement	The batteries in the control box should be replaced periodically.	Replacement every 3 years

4.2.6 Maintenance of the Box

The recommended routine maintenance intervals and work are shown in Table 4-6 below:

Table 4-6 Box maintenance

Inspection content	Inspection methods	Maintenance cycle
System cleaning	Check the cleanliness of the box and clean it.	1 time per year
Earth	Check for loose or corroded screws in the grounding copper drain.	Every 6 months to 1 year (depending on the environment of use)
PCS cabin dust screen	Dust and dirt will cause loss of cooling or heat, the filter should be replaced periodically (the same size as the original filter supplied with the unit).	Every three months or half a year (depending on the environment in which it is used)
Appearances	Check for paint loss on all parts of the box, if any repainting is required.	1 time per year
Tightness	Check that the outdoor cabinet doors are sealed and watertight.	1 time per year

4.2.7 BMS/in Situ Monitoring System Maintenance

The BMS/in-situ monitoring maintenance cycles and tasks are shown in Table 4-7 below:

Table 4-1 BMS/Local monitoring system maintenance

Inspection content	Inspection methods	Maintenance cycle
System status	Check that the system is in a normal state by viewing the system information through the ESMU in the sink cabinet.	1 time per month
SOC calibration	The energy storage system is filled or emptied once to enable the SOC to be calibrated in time to avoid excessive error drift.	1 time per month (depending on frequency of use, 20 cycles should be calibrated)

4.3 Replacement of Electrical and Electronic

When replacing electrical and electronic components in the energy storage system, be



Attention

sure to replace the component products with the same model number from the same manufacturer! The model number of the component can be obtained from the energy storage system logo or the logo of the product itself. If this is not possible, please contact Hindustan Energy Technology.

If there is a need to replace the products of other manufacturers with different models on site, it must be analysed and confirmed by Hindustan Energy Technology in advance. Otherwise, Hindustan Energy Science and Technology will not be responsible for any casualties or property damage caused by it.

BMU Replacement

Note: Please be sure to disconnect all auxiliary power switches and power switches and pull out the MSD for disassembly and installation of the BMU, when installing the BMU, the total positive/negative of the battery cluster must not be connected to the high voltage box, otherwise there is a risk of damage to the device!

Please refer to the contents of "Notes on Power Connection and BMU Replacement" for precautions!

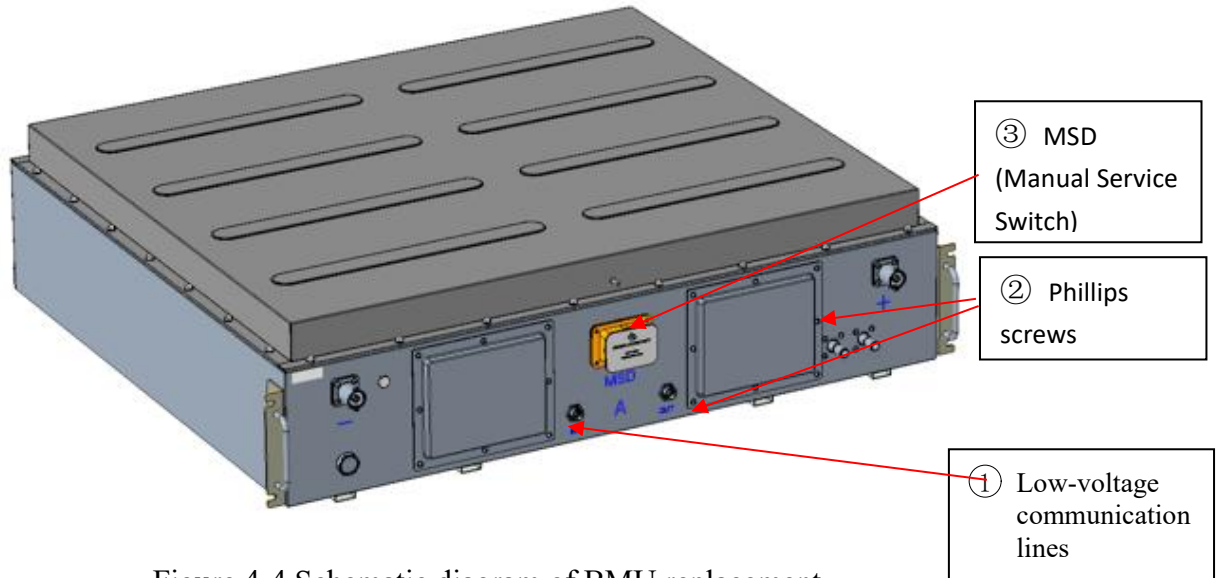

Figure 4-4 Schematic diagram of BMU replacement

- 1、 Unplug the 2 sets of low voltage wires at ① on the BMU.
- 2、 Pull out MSD at ③.
- 3、 Use a Phillips screwdriver to unscrew the eight ② Phillips screws and remove the BMU maintenance window.
- 4、 Use the new BMU to install to the original BMU location.
- 5、 Re-use the Phillips screwdriver to install the eight ② Phillips screws and the BMU protective metal cover.
- 6、 Reinsert the MSD back into its original position and press the black lock button to secure the MSD.

Chapter V Factory Default Parameters

Before the outdoor cabinet is shipped from the factory, the default parameters have been burned into the ESBCM in the high voltage box, and the default values of the alarm and protection parameters are as follows:

Serial number	Sports event	Alarm level	Alarm trigger threshold	Alarm return value	Trigger duration	System control Action	Alarm cancellation conditions	Conditions for lifting the ban on charging and discharging
1	Monoblock overvoltage (V)	Level 11	3.55	0.2	3s	Report alarms	Alarm trigger threshold - return difference value	/
		Level 12	3.6		3s	Charging prohibited; discharging permitted	Alarm trigger threshold - return difference value	The alarm is cancelled and all clusters have discharge current or the average voltage of the current cluster unit is less than 3.3V.
		Level 13	3.65		3s	Output dry node, delay 3s to execute the	Alarm trigger threshold - return	Alarm is cleared and ESMU

						process of jumping machine	difference value	clicks on fault resumption
2	Monoblock voltage too low (V)	Level 11	2.8	0.2	3s	Report alarms	Alarm trigger threshold + return difference value	/
		Level 12	2.7		3s	Charging permitted; discharging prohibited	Alarm trigger threshold + return difference value	Alarm is cleared and all clusters have charging current.
		Level 13	2.6		3s	Output dry node, delay 3s to execute the process of jumping machine	Alarm trigger threshold + return difference value	Alarm is cleared and ESMU clicks on fault resumption
3	Individual voltage differential (mV)	Level 11	300	50	3s	Report Alarms	Alarm trigger threshold - return difference value	/
		Level 12	500		3s	Prohibition of charging; prohibition of discharging	Alarm trigger threshold - return difference value	Alarm cancelled with 30min delay
		Level	700		3s	Output dry	Alarm	Alarm is

		13				node, delay 3s to execute the process of jumping machine	trigger threshold - return difference value	cleared and ESMU clicks on fault resumption
4	High battery charging unit temperature (°C)	Level 11	52	5	3s	Report alarms	Alarm trigger threshold - return difference value	/
		Level 12	57		3s	Charging prohibited; discharging permitted	Alarm trigger threshold - return difference value	Fault resolution
		Level 13	62		3s	Output dry node, delay 3s to execute the process of jumping machine	Alarm trigger threshold - return difference value	Alarm is cleared and ESMU clicks on fault resumption
5	Low battery charging unit temperature (°C)	Level 11	5	3	3s	Report alarms	Alarm trigger threshold + return difference value	/
		Level 12	3		3s	Charging prohibited; discharging permitted	Alarm trigger threshold + return difference	Fault resolution

							e value	
		Level 13	1		3s	Output dry node, delay 3s to execute the process of jumping machine	Alarm trigger threshold + return difference value	Alarm is cleared and ESMU clicks on fault resumption
6	High battery discharge monomer temperature (°C)	Level 11	52	5	3s	Report alarms	Alarm trigger threshold - return difference value	/
		Level 12	57		3s	Charging permitted; discharging prohibited	Alarm trigger threshold - return difference value	Fault resolution
		Level 13	62		3s	Output dry node, delay 3s to execute the process of jumping machine	Alarm trigger threshold - return difference value	ESMU click fault resumption
7	Low battery discharge monomer temperature (°C)	Level 11	-10	5	3s	Report alarms	Alarm trigger threshold + return difference value	/
		Level 12	-15		3s	Charging permitted; discharging	Alarm trigger threshold	Fault resolution

						prohibited	+ return difference value	
		Level 13	-20		3s	Output dry node, delay 3s to execute the process of jumping machine	Alarm trigger threshold + return difference value	ESMU click fault resumption
8	Large temperature difference of single cell (°C)	Level 11	12	3	3s	Report alarms	Alarm trigger threshold - return difference value	/
		Level 12	15		3s	Prohibition of charging; prohibition of discharging	Alarm trigger threshold - return difference value	Fault resolution
		Level 13	18		3s	Output dry node, delay 3s to execute the process of jumping machine	Alarm trigger threshold - return difference value	ESMU click fault resumption
9	Low SOC (1 per cent)	Level 11	15	2	3s	Alarms only	Alarm trigger threshold + return difference value	/
		Level 12	10		3s	Alarms only	Alarm trigger	/

							threshold + return difference value	
		Level 13	5		3s	Alarms only	Alarm trigger threshold + return difference value	/
10	High SOC (1 per cent)	Level 11	101	2	3s	/	/	/
		Level 12	101		3s	/	/	/
		Level 13	101		3s	/	/	/
11	Total voltage too high (V)	Level 11	$3.55 \times 384 = 1363.2$	10	3s	Report Alarms	Alarm trigger threshold - return difference value	/
		Level 12	$3.60 \times 384 = 1382.4$		3s	Charging prohibited; discharging permitted	Alarm trigger threshold - return difference value	Alarm cleared and all clusters have discharge current
		Level 13	$3.65 \times 384 = 1401.6$		3s	Output dry node, delay 3s to execute the process of jumping machine	Alarm trigger threshold - return difference value	ESMU click fault resumption
12	Total voltage	Level 11	$2.7 \times 384 = 1036.8$	10	3s	Report Alarms	Alarm trigger	/

	too low (V)						threshold + return differenc e value	
		Leve 12	2.60*38 4=998.4		3s	Charging permitted; discharging prohibited	Alarm trigger threshold + return differenc e value	Alarm is cleared and all clusters have charging current.
		Leve 13	2.5*384 =960		3s	Output dry node, delay 3s to execute the process of jumping machine	Alarm trigger threshold + return differenc e value	ESMU click fault resumptio n
13	Power plug-in temperat ure over-tem perature alarm (°C)	Leve 11	90	5	3s	Report Alarms	Alarm trigger threshold - return differenc e value	/
		Leve 12	95		3s	Prohibition of charging; prohibition of discharging	Alarm trigger threshold - return differenc e value	Fault resolution
		Leve 13	100		3s	Output dry node, delay 3s to execute the process of jumping machine	Alarm trigger threshold - return differenc e value	ESMU click fault resumptio n
14	Charge	Leve	320	10	3s	Report	Alarm	/

	overcurrent (A)	11				alarms	trigger threshold - return difference value	
		Level 12	330		3s	Charging prohibited; discharging permitted	Alarm trigger threshold - return difference value	Alarm cancelled and (30min delay or all clusters have discharge current)
		Level 13	345		3s	Output dry node, delay 3s to execute the process of jumping machine	Alarm trigger threshold - return difference value	ESMU click fault resumption
15	Discharge overcurrent (A)	Level 11	320		3s	Report alarms	Alarm trigger threshold - return difference value	/
		Level 12	330		3s	Charging permitted; discharging prohibited	Alarm trigger threshold - return difference value	Alarm cleared and (30min delay or all clusters have charging current)
		Level	345		3s	Output dry	Alarm	ESMU

		13				node, delay 3s to execute the process of jumping machine	trigger threshold - return difference value	click fault resumption	
16	low insulation	Level 11	2000	10	10 S/60s	Charging permitted; discharging permitted	Alarm trigger threshold + return difference value	/	
	(KΩ)	Level 12	1800			10 S/60s	Prohibition of discharge; prohibition of charging	Alarm trigger threshold + return difference value	Fault resolution
		Level 13	1500			10 S/60s	Output dry node, delay 3s to execute the process of jumping machine	Alarm trigger threshold + return difference value	ESMU click fault resumption
17	Battery box voltage too high (V)	Level 11	$3.55 \times 48 = 170.4$	5	3s	Report alarms	Alarm trigger threshold - return difference value	/	
		Level 12	$3.60 \times 48 = 172.8$			3s	Charging prohibited; discharging permitted	Alarm trigger threshold - return difference value	Alarm cleared and all clusters have discharge current

		Level 13	$3.65 \times 48 = 175.2$		3s	Output dry node, delay 3s to execute the process of jumping machine	Alarm trigger threshold - return difference value	ESMU click fault resumption
18	Battery box voltage too low (V)	Level 11	$2.7 \times 48 = 139.6$	5	3s	Report alarms	Alarm trigger threshold + return difference value	/
		Level 12	$2.6 \times 48 = 124.8$		3s	Charging permitted; discharging prohibited	Alarm trigger threshold + return difference value	Alarm is cleared and all clusters have charging current.
		Level 13	$2.5 \times 48 = 120$		3s	Output dry node, delay 3s to execute the process of jumping machine	Alarm trigger threshold + return difference value	ESMU click fault resumption
19	Failure of communication between display control and BCU	Level 13			3s	Output dry node, delay 3s to execute the process of jumping machine	Alarm trigger threshold + return difference value	ESMU click fault resumption
20	BCU and BMU communication failure	Level 13			3s	Output dry node, delay 3s to execute the process of	Communications restored	ESMU click fault resumption

						jumping machine		
21	Display control detects external signals: fire fault/emergency stop signal/electrical operation	Level 13			2s	Output dry node, delay 3s to execute the process of jumping machine	Real-time monitoring	ESMU click fault resumption
22	Single voltage acquisition Fault	Level 13			3s	Output dry node, delay 3s to execute the process of jumping machine	Data Sampling Recovery	ESMU click fault resumption
23	Failure of monomer temperature acquisition	Level 13	Number of invalid temperatures ≥ 6 or number of slaves with invalid temperatures ≥ 3		3s	Output dry node, delay 3s to execute the process of jumping machine	Data sampling recovery	ESMU click fault resumption
24	Temperature rise alarm	Level 12	Temperature rise rate of single cell		3s	Prohibition of charging; prohibition of discharging	Temperature rise rate of single cell temperature	Fault resolution

			tempera ture >> 10°C/mi n			ure ≤10°C/mi n		
25	Master: circuit breaker failure/C ontactor failure	Leve l 3			3s	Output dry node, delay 3s to execute the process of jumping machine	Test Recovery	ESMU click fault resumptio n
26	Slave periphera l failure (DI detection)	Leve l 1			3s	Warning	Real-time monitorin g	/
27	Inter-clus ter current imbalance alarm	Leve l 1	Minimu m clust er curre nt *1.25 < maxi mum cl uster cu rrent, an d stack current > 15A		60 S	Warning	Failure condition s not met	/

Chapter VI Failure Analysis and Handling

Under fault conditions, lethal high voltage may still be present within the energy storage.



Warning

- Only qualified technicians may perform the operations described in this chapter. "Compliant" means that the operator has had prior professional training in the troubleshooting operations of the equipment.
- Perform only the troubleshooting operations described in this manual.
- Observe all safety practices when operating.

If the problem cannot be solved with the help of this manual or if you still have questions, please contact Hindustan Energy Technologies. We need the following information in order to provide you with faster and better service:

- Energy storage system model.
- Energy storage system serial number.
- Information on the manufacturers and models of the relevant components connected to the energy storage system, and the configuration of the storage battery.
- Communication connectivity solutions for energy storage systems.
- Fault message and brief description.
- Photographs of the failure site (if site conditions permit).

6.1 Troubleshooting

When the energy storage system does not output as expected or the charge/discharge amount changes abnormally, check the following before consulting with our maintenance personnel:

- The open circuit voltage of the storage battery.
- Is the grid properly connected and energized.
- Check for proper communication with the energy storage system external EMS, PCS, etc.

6.2 Common Troubleshooting Chart

Component	Fault type	Cause of the problem	Prescription
Cell	Decline in efficiency	1、 long time use, individual Battery cell aging serious;	1、 Replace the aging and serious Battery cell;
		2、 long time use, individual Battery cell consistency is poor;	2、 Manual equalisation of cells with very poor consistency.
	Excessive cell pressure difference	The consistency of the cells inside the PACK decreases with prolonged use.	Manual equalisation
	Voltage too low to start after overdrive	1、 Idle for a long time after discharging, resulting in the voltage of the battery cell below the threshold;	1、 Idle energy storage systems for long periods of time need to be charged and discharged every other month;
		2、 After emptying, some DC loads are not cut off and still consume DC energy.	2、 When not in use for a long time, it is necessary to cut off the load on the DC side.
	Low voltage of single cell	1、 Failure of the Battery cell;	1、 Replace the Battery cell;
		2、 Serious aging of the single Battery cell;	2、 Replace the badly aged Battery cell;
		3、 Poor single-cell consistency.	3、 Manual equalisation of cells with very poor consistency.
	SOC cannot be calibrated	1、 The voltage of the Battery cell exceeds the normal value;	1、 The voltage of the reference single cell is too low;
		2、 The indoor temperature does not meet the requirements.	2、 Bring the room temperature back to STC conditions.
PACK	Battery pack abnormality	1、 BMU failure;	1、 Replace the BMU;
		2、 The PACK code is not correct.	2、 Generally the PACK is sent to the site separately, and it is necessary to re-address the PACK.

BMU	Communications anomaly	CAN disconnection	Change line
	Differential pressure anomaly	If the differential pressure inside the PACK is abnormal, it is usually a BMU failure	Replacement of BMU
	Single-cell anomalies	If the wiring is normal, it's usually a BMU failure	Replacement of BMU
	Crash (of a plane)	BMU failure	Replacement of BMU
BCMU & Master Control Box	Communications anomaly	1、 Loose communication lines;	1、 Find loose wiring and restore.
		2、 CAN disconnection;	2、 Change the line.
		3、 Line interference;	3、 Find sources of interference, PCS topology, etc.
		4. Terminating resistor not added.	4. Check whether the terminal resistance value meets the requirements.
	Battery cluster failure	1、 Find out if the fault really exists;	1、 Solve the corresponding faults, such as over-current, over-temperature, fuse damage, etc.;
		2、 If there is no fault, find out if the BCMU parameters are configured incorrectly;	2、 Parameters are configured to reasonable values.
	Indicator light abnormality	1、 Abnormal power input;	1、 Restore the power input value to 24VDC;
	Battery cluster isolated	Loose connector	Re-insertion of connectors
	Temperature anomaly	1、 Poor contact of internal devices;	1、 Find out if the device is loose and restore it;
		2、 Temperature sampling probe aging;	2、 Replace the aged probe;
		3、 The temperature sampling probe is not in the right position;	3、 Avoid heat generating devices;
		4、 The application environment is not right.	4、 Use in accordance with the permitted conditions of the energy storage system.

	SOC anomaly	A long run cut did not trigger a calibration condition.	Filling or draining every other month to enable the BMS to calibrate the SOC.
	Excessive pressure difference between cell clusters	1、 Problems in setting the protection value for differential pressure between clusters.	1、 Adjust the appropriate inter-cluster pressure difference according to the end voltage.
		2、 No automatic segregation is set.	2、 Automatic isolation of inputs.
	Main control box device failure	1、 The fuse is damaged;	Replacement devices
		2、 Contactor damaged.	
Water cooler	Compressor won't start	1、 No power on.	Replacement of damaged devices
		2、 Power supply overload air switch jumped open.	
		3、 Loose circuit connections.	
	Excessive compressor noise	1、 Check for fluid leaks, perform repairs and add refrigerant.	Adding refrigerant and replacing damaged parts
		2、 Replace the filter.	
		3、 Replace the expansion valve.	
Cabinet	Outdoor cabinets leak	Screws loosened in transit;	Tighten all screws.
	Outdoor cabinet compartment over-temperature	Filter wool not cleaned	Regular cleaning and maintenance of filter wool
	Outdoor cabinet rusting	Outdoor cabinets are not repainted in a timely manner in damaged areas	Regularly inspect outdoor cabinet for paint breakage and deal with it in a timely manner
Fire-fighting	backup power failure	Battery backup failure	Replacement of backup battery